

37000 kg (81571 lb)

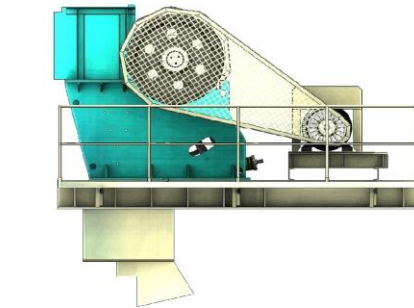

22000 kg (48501 lb)

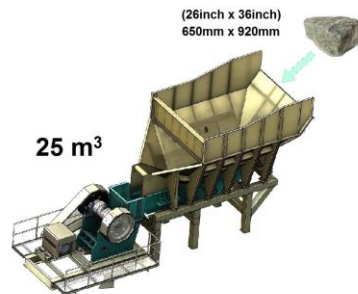
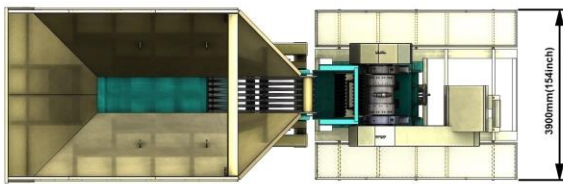
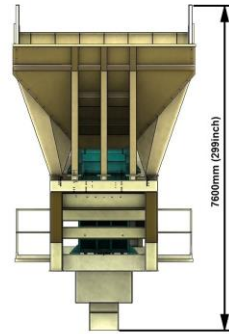
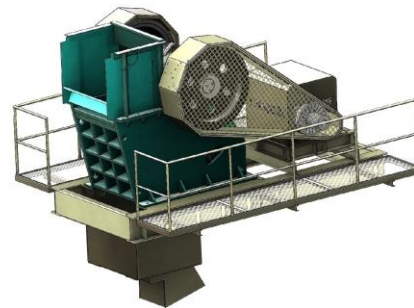
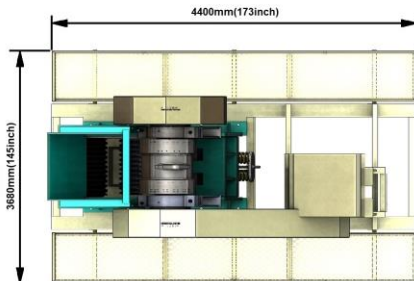
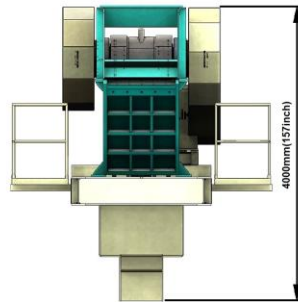

16000 kg (35274 lb)

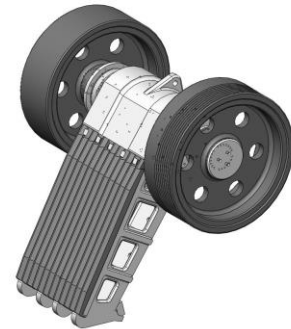
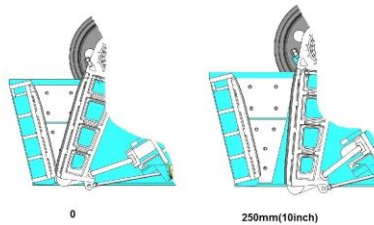
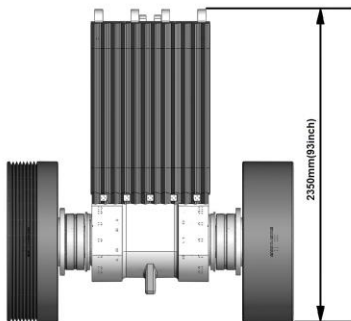
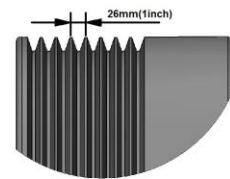
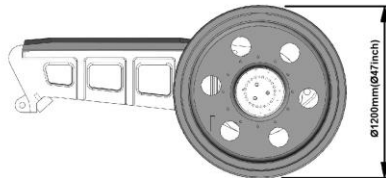
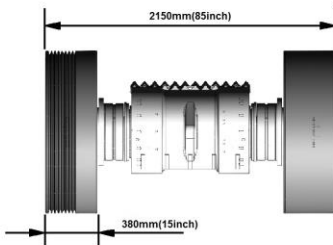
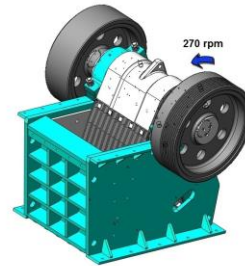
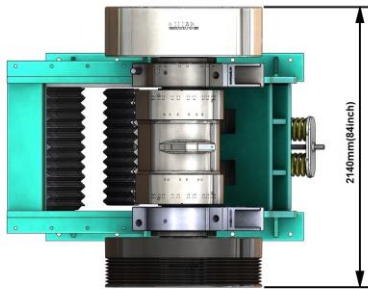
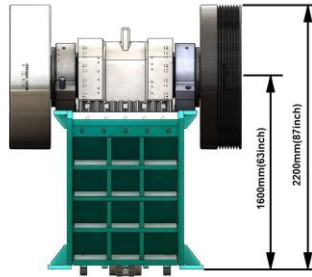
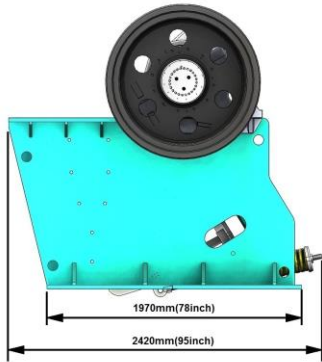

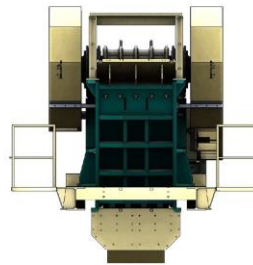
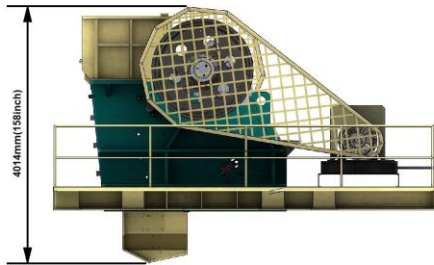
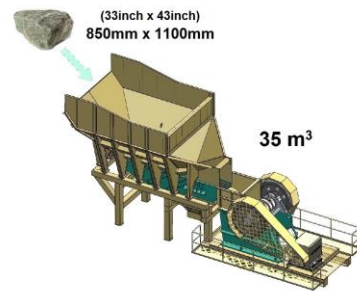
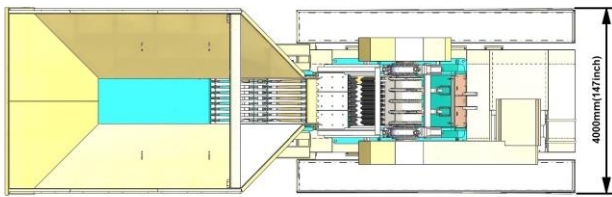
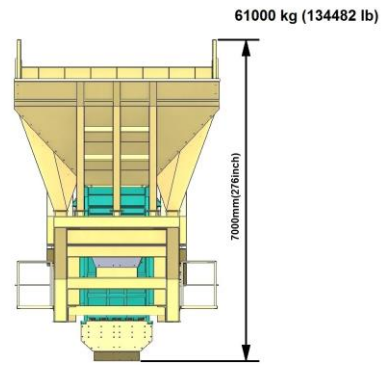
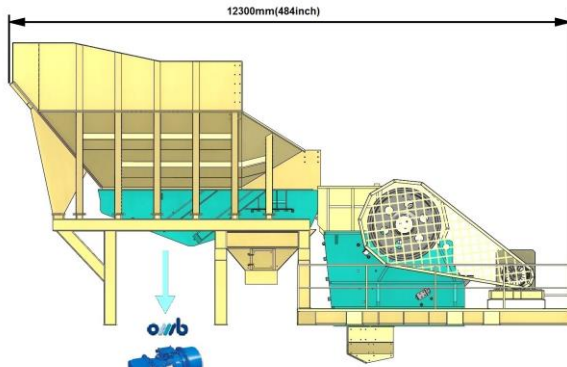

43000 kg (94799 lb)

GAMAK
www.gamak.com

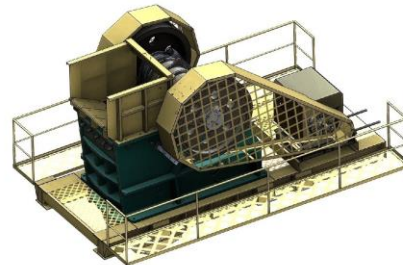
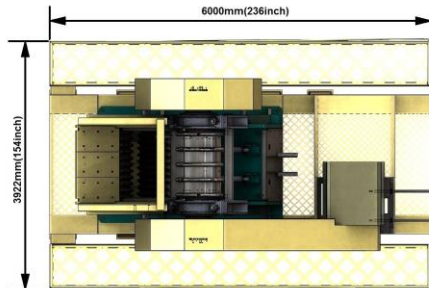

37000 kg (81571 lb)

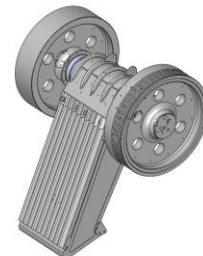
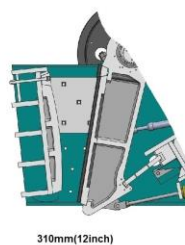
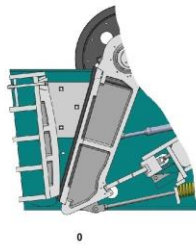
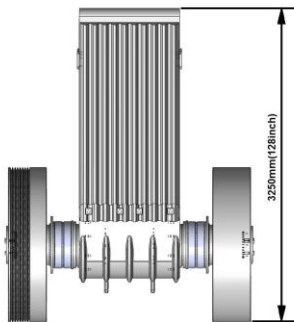
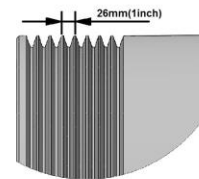
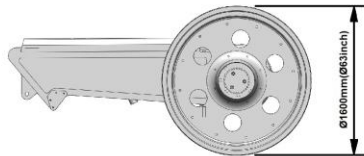
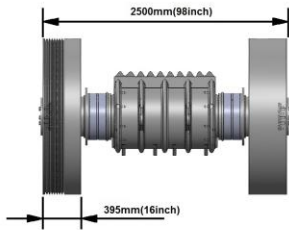
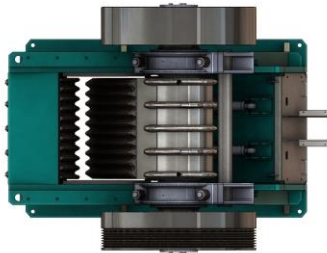
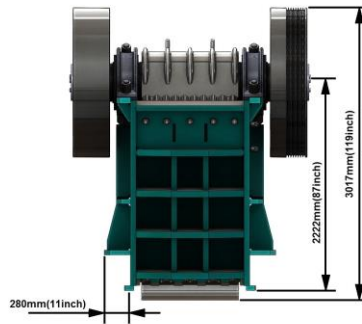
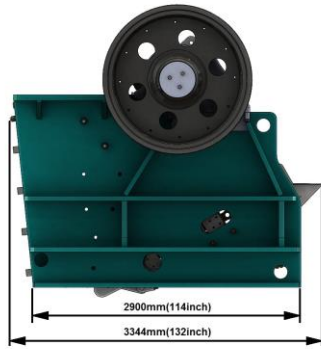

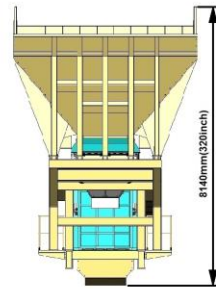
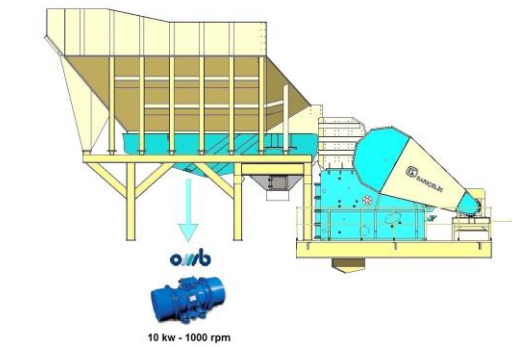

87000 kg (191802 lb)

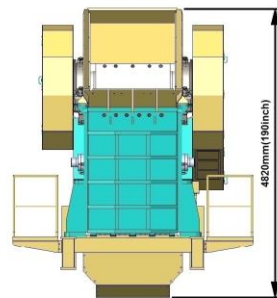
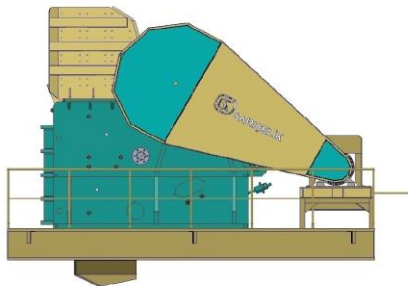
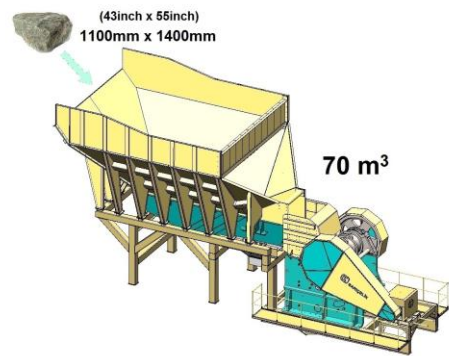
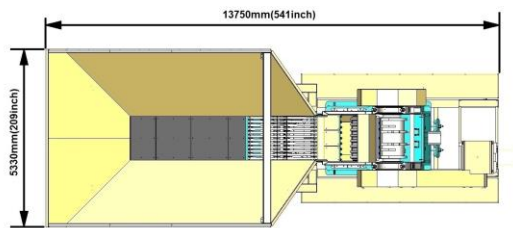

57000 kg (125663 lb)

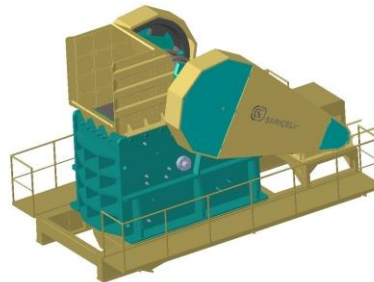
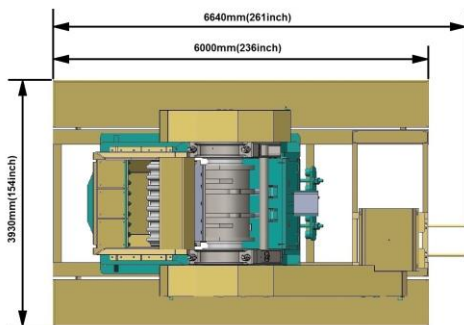

47000 kg (103617 lb)

